

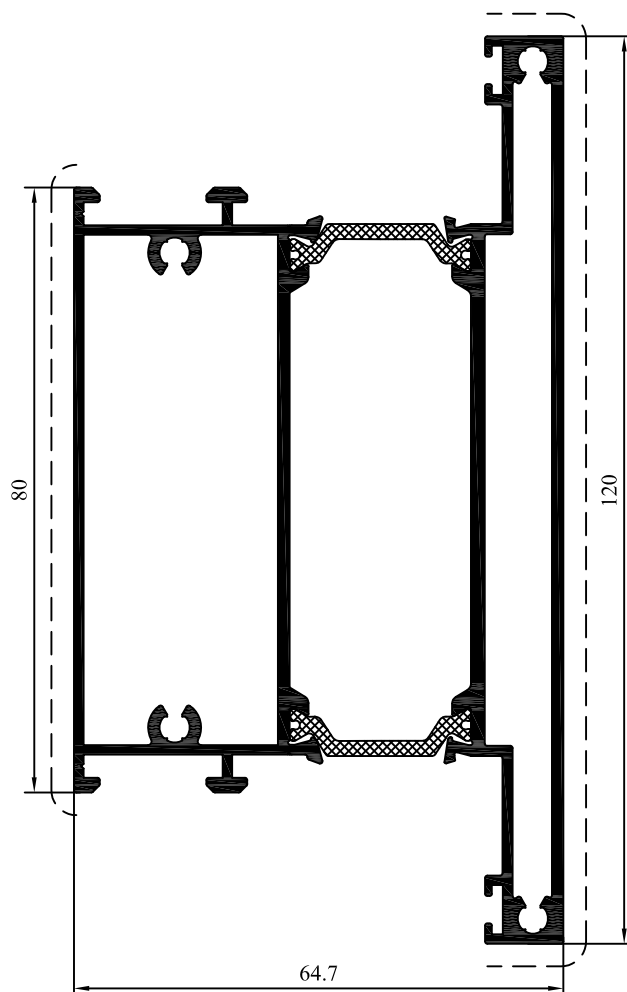

TE 2612





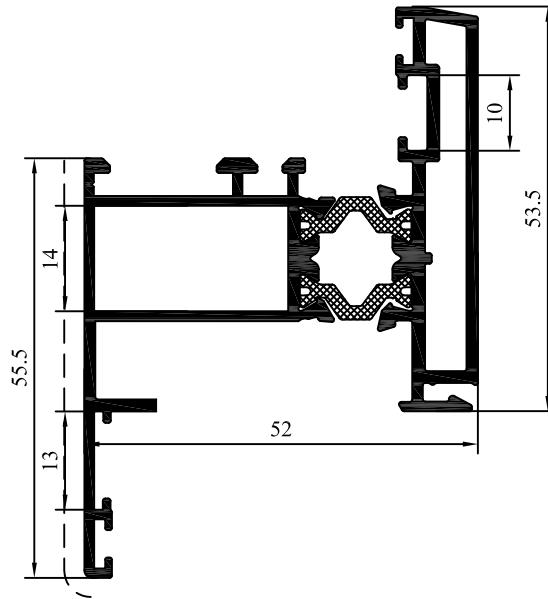

Perfil		P. Teórico	Área Trata. / Pol.	Momentos de Inércia
TE-2612		2.35	0.61 / 0.24	$I_x = - / I_y = -$
TE-2612/B		1.30	0.32 / 0.15	$I_x = - / I_y = -$
TE-2212/A		1.05	0.29 / 0.09	$I_x = - / I_y = -$
Acessórios:				

— — - Área Polimento





TE 2244

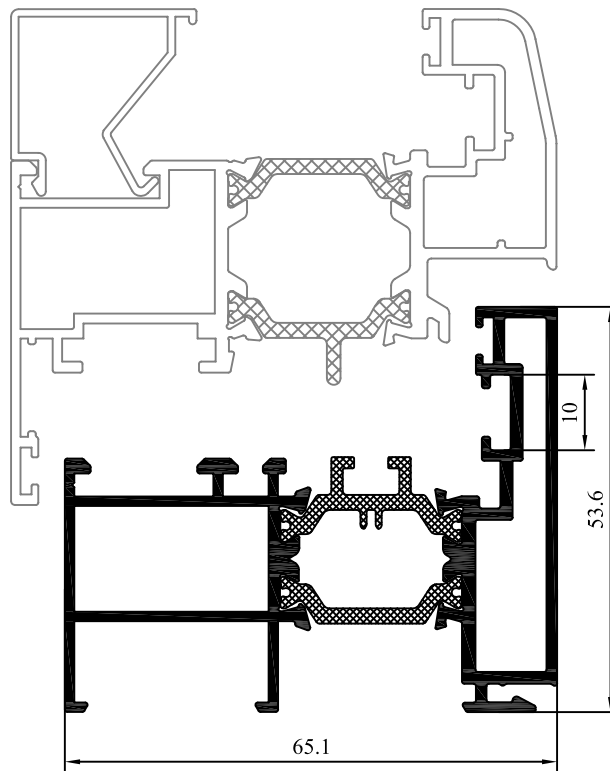

Perfil		P. Teórico	Área Trata. / Pol.	Momentos de Inércia
TE-2244		1.37	0.43 / 0.11	$I_x = - / I_y = -$
TE-2244/B		0.68	0.20 / 0.05	$I_x = - / I_y = -$
TE-2242/A		0.69	0.27 / 0.06	$I_x = - / I_y = -$
Acessórios:	ES.AP.T2514C.BC ES.AL.EACOR60.BC ES.AL.N3.CC			





TE 2640

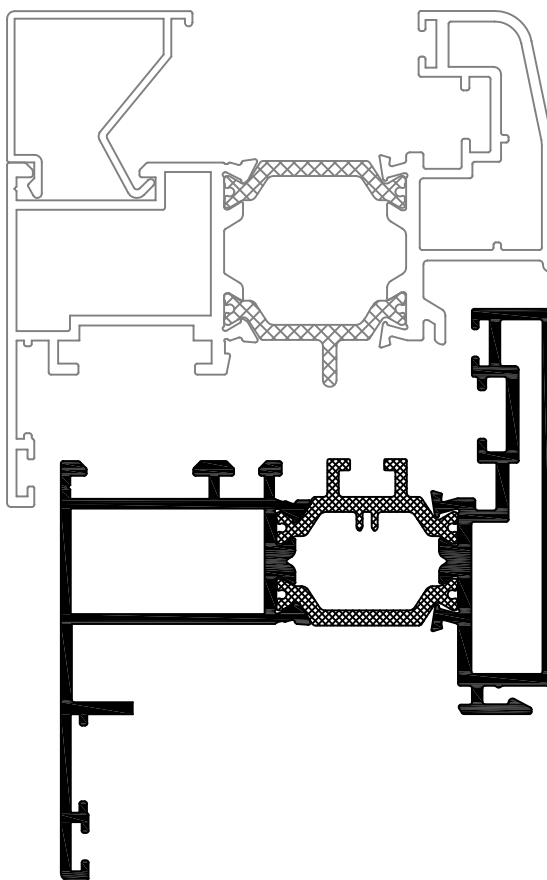

Perfil		P. Teórico	Área Trata. / Pol.	Momentos de Inércia
TE-2640		1.26	0.39 / 0.09	-
TE-2642/B		0.69	0.21 / 0.06	-
TE-2240/A		0.57	0.22 / 0.03	-
Acessórios:		ES.AP.T2514C.BC	ES.AL.EACOR60.BC	





TE 2642

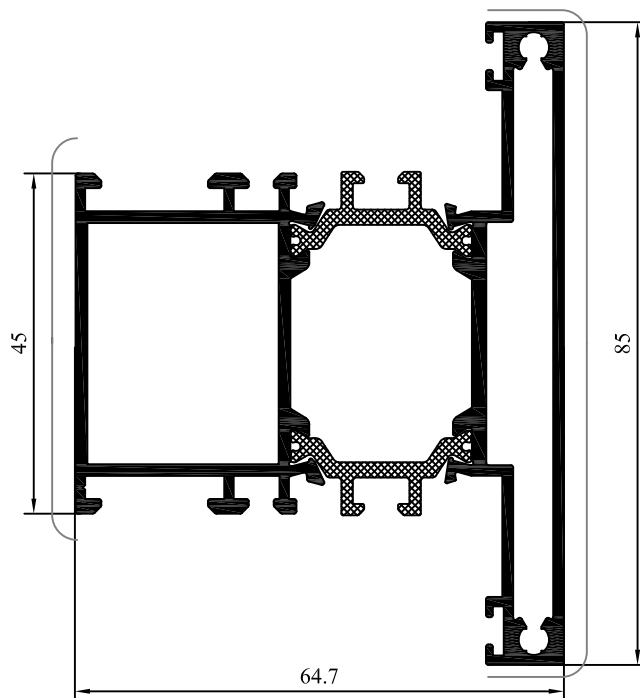

Perfil		P. Teórico	Área Trata. / Pol.	Momentos de Inércia
TE-2642		1.38	0.44 / 0.12	-
TE-2642/B		0.69	0.21 / 0.06	-
TE-2242/A		0.69	0.27 / 0.06	-
Acessórios:	ES.AP.T2514C.BC ES.AL.EACOR60.BC ES.AL.N3.CC			

TE 2651



Perfil		P. Teórico	Área Trata. / Pol.	Momentos de Inércia
TE-2651		1.76	0.45 / 0.15	-
TE-2639/B		0.97	0.25 / 0.10	-
TE-2251/A		0.79	0.24 / 0.05	-
Acessórios:				

— — - Área Polimento

TE 2639

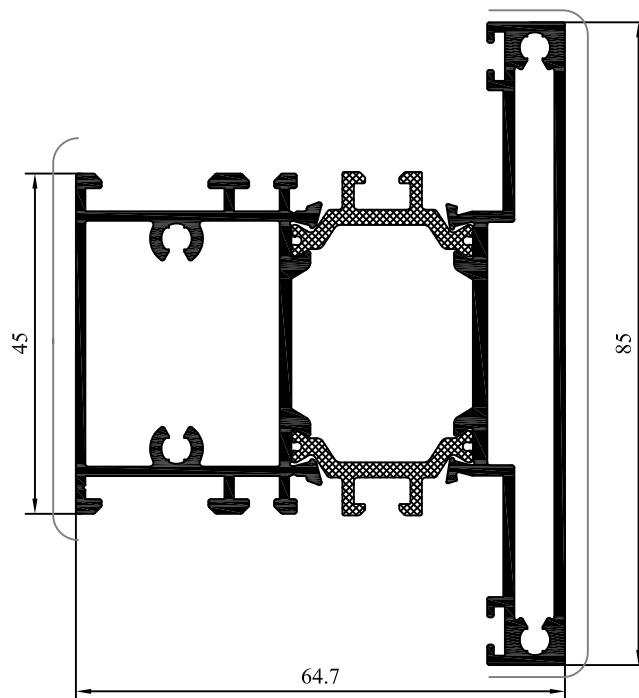



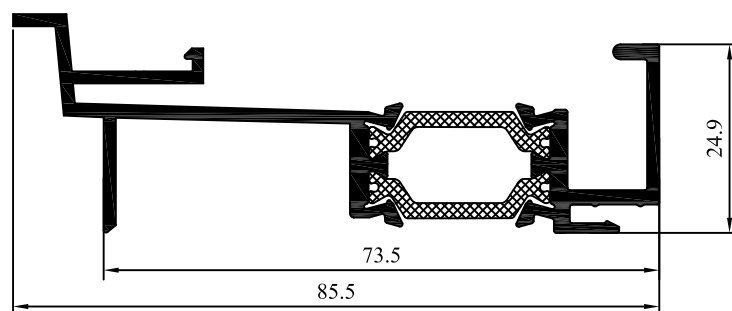

Perfil		P. Teórico	Área Trata. / Pol.	Momentos de Inércia
TE-2639		1.79	0.45 / 0.15	-
TE-2639/B		0.97	0.25 / 0.10	-
TE-2239/A		0.82	0.24 / 0.05	-
Acessórios:				

— — - Área Polimento





TE 2662

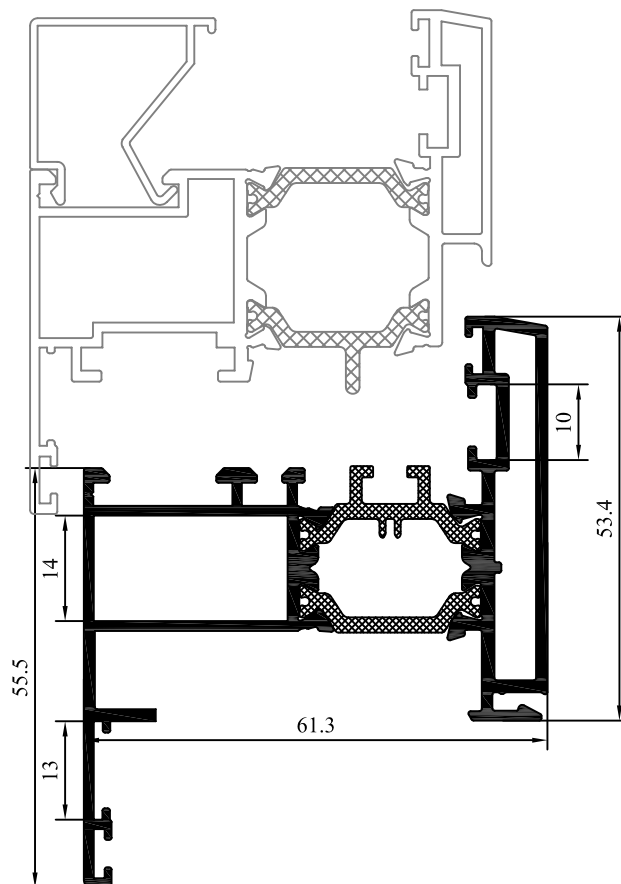

Perfil		P. Teórico	Área Trata. / Pol.	Momentos de Inércia
TE-2662		0.94	0.40 / 0.03	$I_x = - / I_y = -$
TE-2662/B		0.37	0.15 / 0.03	$I_x = - / I_y = -$
TE-2264/A		0.58	0.25 / 0.00	$I_x = - / I_y = -$
Acessórios:				

TE 2244X



Perfil		P. Teórico	Área Trata. / Pol.	Momentos de Inércia
TE-2244X		1.37	0.43 / 0.11	$I_x = - / I_y = -$
TE-2244/B		0.68	0.20 / 0.05	$I_x = - / I_y = -$
TE-2242/A		0.69	0.27 / 0.06	$I_x = - / I_y = -$
Acessórios:	ES.AP.T2514C.BC ES.AL.EACOR60.BC ES.AL.N3.CC			